

- ★ 100% EAS Guaranteed
- ★ Green Device Available
- ★ Super Low Gate Charge
- ★ Excellent CdV/dt effect decline
- ★ Advanced high cell density Trench technology



Product Summary

BVDSS	RDSON	ID
60V	28mΩ	25A

Description

The XXW25N06 is the high cell density trenched N-ch MOSFETs, which provide excellent RDSON and gate charge for most of the synchronous buck converter applications.

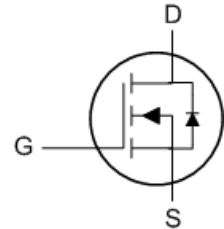
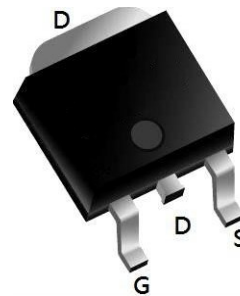
The XXW25N06 meet the RoHS and Green Product requirement, 100% EAS guaranteed with full function reliability approved.

TO252 Pin Configuration

Absolute Maximum Ratings ($T_C=25^{\circ}\text{C}$ unless otherwise specified)

Symbol	Parameter	Max.	Units
V_{DSS}	Drain-Source Voltage	60	V
V_{GSS}	Gate-Source Voltage	± 20	V
I_D	Continuous Drain Current	$T_C = 25^{\circ}\text{C}$	20
		$T_C = 100^{\circ}\text{C}$	13
I_{DM}	Pulsed Drain Current ^{note1}	80	A
EAS	Single Pulsed Avalanche Energy ^{note2}	18	mJ
P_D	Power Dissipation	$T_C = 25^{\circ}\text{C}$	27.7
$R_{\theta JC}$	Thermal Resistance, Junction to Case	5.4	$^{\circ}\text{C/W}$
T_J, T_{STG}	Operating and Storage Temperature Range	-55 to +175	$^{\circ}\text{C}$

Electrical Characteristics ($T_J=25^\circ\text{C}$ unless otherwise specified)

Symbol	Parameter	Test Condition	Min.	Typ.	Max.	Units
Off Characteristic						
$V_{(BR)DSS}$	Drain-Source Breakdown Voltage	$V_{GS}=0V, I_D=250\mu A$	60	-	-	V
I_{DSS}	Zero Gate Voltage Drain Current	$V_{DS}=60V, V_{GS}=0V,$	-	-	1.0	μA
I_{GSS}	Gate to Body Leakage Current	$V_{DS}=0V, V_{GS}=\pm 20V$	-	-	± 100	nA
On Characteristics						
$V_{GS(th)}$	Gate Threshold Voltage	$V_{DS}=V_{GS}, I_D=250\mu A$	1.0	1.6	2.5	V
$R_{DS(on)}$	Static Drain-Source on-Resistance <small>note3</small>	$V_{GS}=10V, I_D=10A$	-	28	35	m Ω
		$V_{GS}=4.5V, I_D=5A$	-	33	45	
Dynamic Characteristics						
C_{iss}	Input Capacitance	$V_{DS}=25V, V_{GS}=0V,$ $f=1.0MHz$	-	1148	-	pF
C_{oss}	Output Capacitance		-	58.5	-	pF
C_{rss}	Reverse Transfer Capacitance		-	49.4	-	pF
Q_g	Total Gate Charge	$V_{DS}=30V, I_D=10A,$ $V_{GS}=10V$	-	20.3	-	nC
Q_{gs}	Gate-Source Charge		-	3.7	-	nC
Q_{gd}	Gate-Drain("Miller") Charge		-	5.3	-	nC
Switching Characteristics						
$t_{d(on)}$	Turn-on Delay Time	$V_{DS}=30V, I_D=20A,$ $R_G=1.8\Omega, V_{GS}=10V$	-	7.6	-	ns
t_r	Turn-on Rise Time		-	20	-	ns
$t_{d(off)}$	Turn-off Delay Time		-	15	-	ns
t_f	Turn-off Fall Time		-	24	-	ns
Drain-Source Diode Characteristics and Maximum Ratings						
I_S	Maximum Continuous Drain to Source Diode Forward Current		-	-	25	A
I_{SM}	Maximum Pulsed Drain to Source Diode Forward Current		-	-	80	A
V_{SD}	Drain to Source Diode Forward Voltage	$V_{GS}=0V, I_S=20A$	-	-	1.2	V
t_{rr}	Body Diode Reverse Recovery Time	$I_F=20A, di/dt=100A/\mu s$	-	29	-	ns
Q_{rr}	Body Diode Reverse Recovery Charge		-	43	-	nC

Notes:1. Repetitive Rating: Pulse Width Limited by Maximum Junction Temperature

2. EAS condition : $T_J=25^\circ\text{C}, V_{DD}=30V, V_G=10V, L=0.5mH, R_g=25\Omega, I_{AS}=8.5A$

3. Pulse Test: Pulse Width $\leq 300\mu s$, Duty Cycle $\leq 0.5\%$

Typical Performance Characteristics

Figure 1: Output Characteristics

Figure 2: Typical Transfer Characteristics

Figure 3: On-resistance vs. Drain Current

Figure 4: Body Diode Characteristics

Figure 5: Gate Charge Characteristics

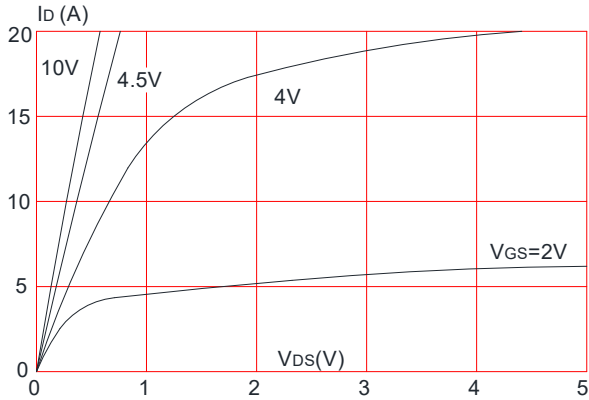
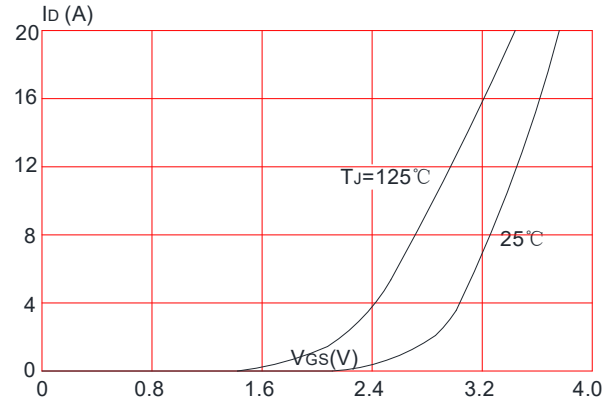
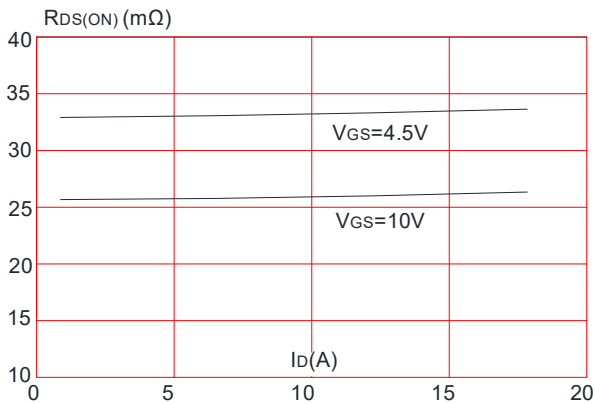
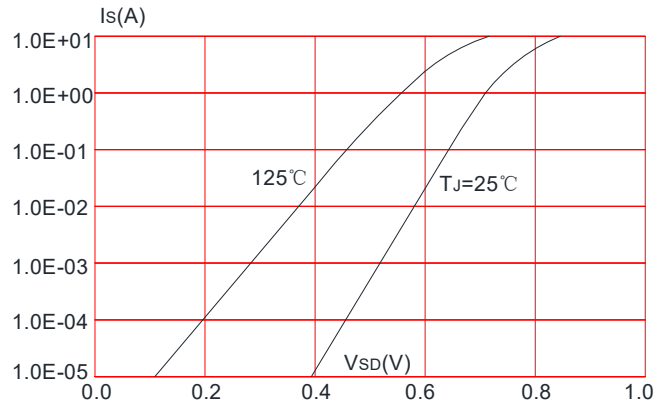
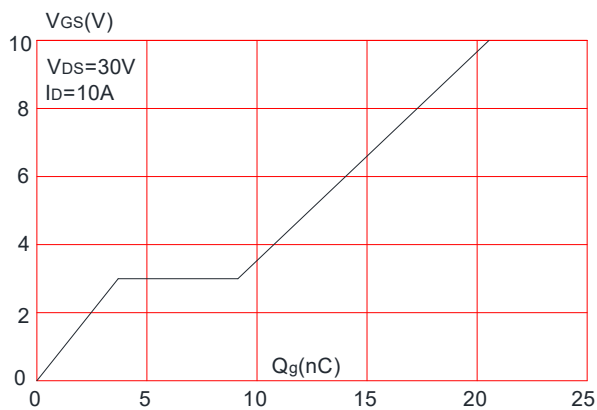
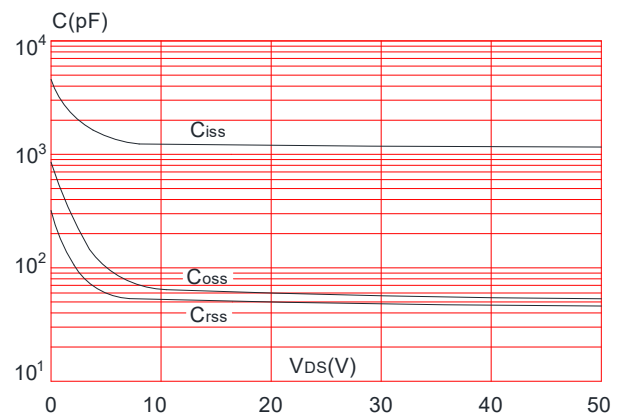
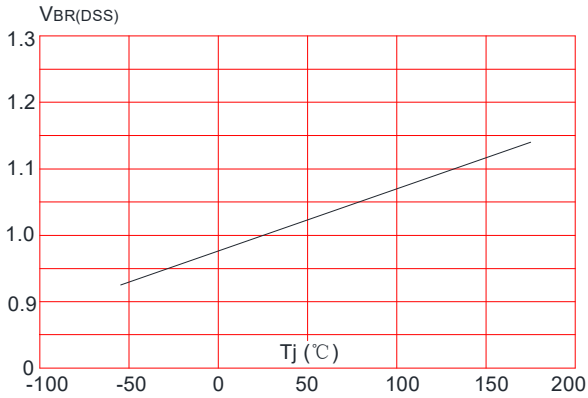
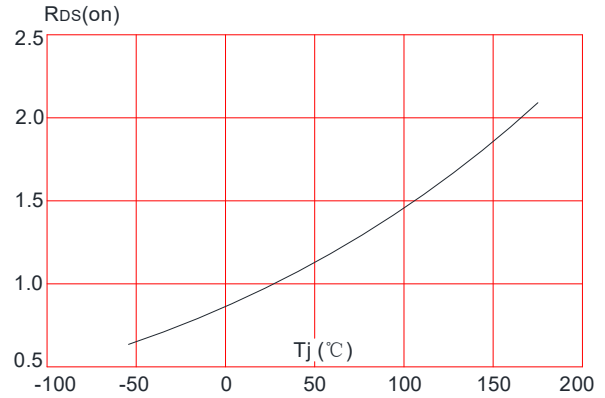
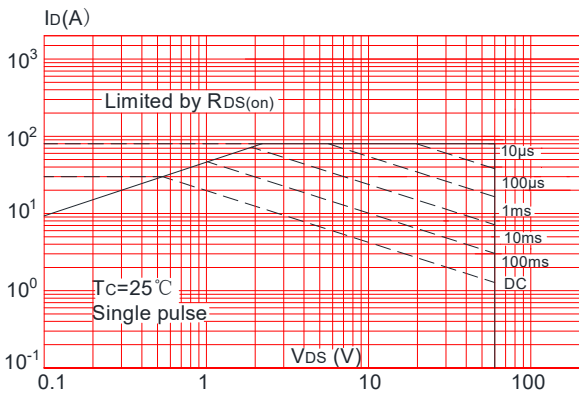
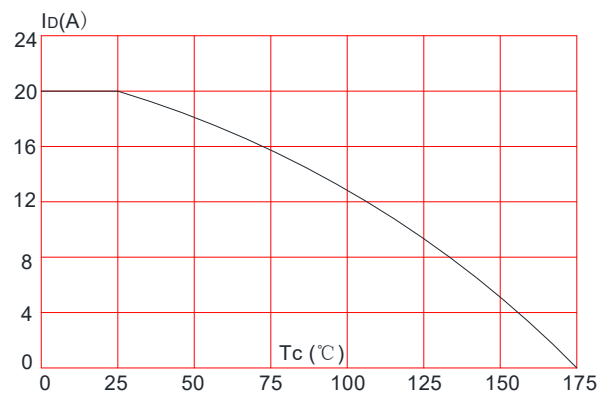
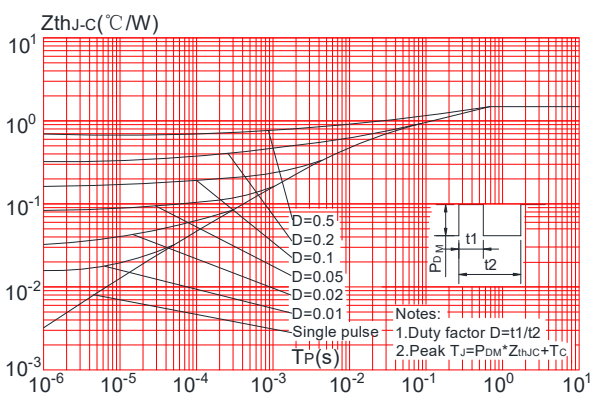
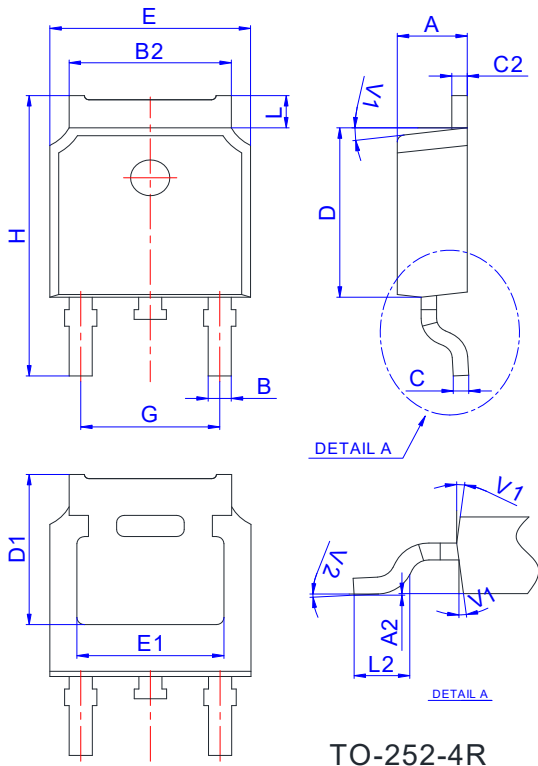
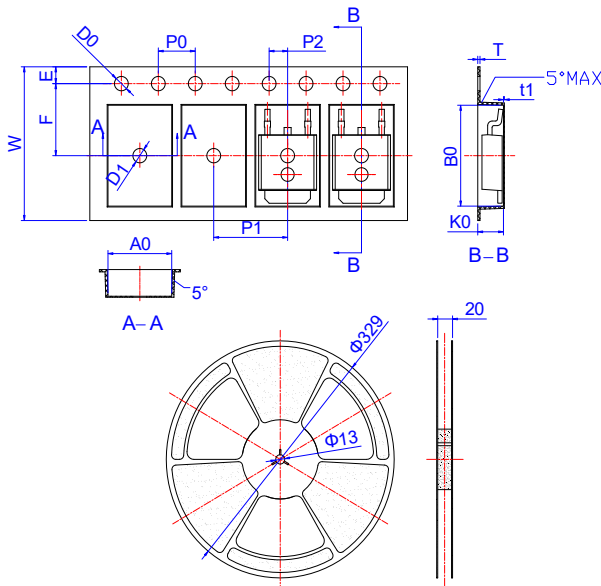
Figure 6: Capacitance Characteristics

Figure 7: Normalized Breakdown Voltage vs. Junction Temperature

Figure 8: Normalized on Resistance vs. Junction Temperature

Figure 9: Maximum Safe Operating Area

Figure 10: Maximum Continuous Drain Current vs. Case Temperature

Figure.11: Maximum Effective Transient Thermal Impedance, Junction-to-Case

Package Mechanical Data-TO-252

Ref.	Dimensions					
	Millimeters			Inches		
	Min.	Typ.	Max.	Min.	Typ.	Max.
A	2.10		2.50	0.083		0.098
A2	0		0.10	0		0.004
B	0.66		0.86	0.026		0.034
B2	5.18		5.48	0.202		0.216
C	0.40		0.60	0.016		0.024
C2	0.44		0.58	0.017		0.023
D	5.90		6.30	0.232		0.248
D1	5.30REF			0.209REF		
E	6.40		6.80	0.252		0.268
E1	4.63			0.182		
G	4.47		4.67	0.176		0.184
H	9.50		10.70	0.374		0.421
L	1.09		1.21	0.043		0.048
L2	1.35		1.65	0.053		0.065
V1		7°			7°	
V2	0°		6°	0°		6°

Reel Specification-TO-252

Ref.	Dimensions					
	Millimeters			Inches		
	Min.	Typ.	Max.	Min.	Typ.	Max.
W	15.90	16.00	16.10	0.626	0.630	0.634
E	1.65	1.75	1.85	0.065	0.069	0.073
F	7.40	7.50	7.60	0.291	0.295	0.299
D0	1.40	1.50	1.60	0.055	0.059	0.063
D1	1.40	1.50	1.60	0.055	0.059	0.063
P0	3.90	4.00	4.10	0.154	0.157	0.161
P1	7.90	8.00	8.10	0.311	0.315	0.319
P2	1.90	2.00	2.10	0.075	0.079	0.083
A0	6.85	6.90	7.00	0.270	0.271	0.276
B0	10.45	10.50	10.60	0.411	0.413	0.417
K0	2.68	2.78	2.88	0.105	0.109	0.113
T	0.24		0.27	0.009		0.011
t1	0.10			0.004		
10P0	39.80	40.00	40.20	1.567	1.575	1.583