

- ★ Green Device Available
- ★ Super Low Gate Charge
- ★ Excellent Cdv/dt effect decline
- ★ Advanced high cell density Trench technology



**Product Summary**

BVDSS	RDSON	ID
20V	19mΩ	6.0A

**Description**

The SI2300 is the high cell density trenched N-ch MOSFETs, which provides excellent RDSON and efficiency for most of the small power switching and load switch applications.

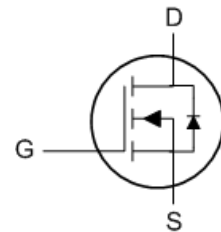
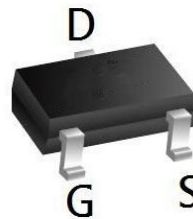
The SI2300 meet the RoHS and Green Product requirement with full function reliability approved.

**SOT23 Pin Configuration**

**Absolute Maximum Ratings**

Symbol	Parameter	Rating	Units
$V_{DS}$	Drain-Source Voltage	20	V
$V_{GS}$	Gate-Source Voltage	$\pm 12$	V
$I_D@T_A=25^\circ\text{C}$	Continuous Drain Current, $V_{GS} @ 4.5V^1$	6.0	A
$I_D@T_A=70^\circ\text{C}$	Continuous Drain Current, $V_{GS} @ 4.5V^1$	4.0	A
$I_{DM}$	Pulsed Drain Current <sup>2</sup>	15.0	A
$P_D@T_A=25^\circ\text{C}$	Total Power Dissipation <sup>3</sup>	1	W
$T_{STG}$	Storage Temperature Range	-55 to 150	$^\circ\text{C}$
$T_J$	Operating Junction Temperature Range	-55 to 150	$^\circ\text{C}$

**Thermal Data**

Symbol	Parameter	Typ.	Max.	Unit
$R_{\theta JA}$	Thermal Resistance Junction-ambient <sup>1</sup>	---	125	$^\circ\text{C/W}$
$R_{\theta JC}$	Thermal Resistance Junction-Case <sup>1</sup>	---	80	$^\circ\text{C/W}$

**Electrical Characteristics (T<sub>J</sub>=25 °C, unless otherwise noted)**

Symbol	Parameter	Conditions	Min.	Typ.	Max.	Unit
BV <sub>DSS</sub>	Drain-Source Breakdown Voltage	V <sub>GS</sub> =0V, I <sub>D</sub> =250uA	20	---	---	V
R <sub>DS(ON)</sub>	Static Drain-Source On-Resistance <sup>2</sup>	V <sub>GS</sub> =4.5V, I <sub>D</sub> =3A	---	19	35	mΩ
		V <sub>GS</sub> =2.5V, I <sub>D</sub> =2A	---	35	60	
V <sub>GS(th)</sub>	Gate Threshold Voltage	V <sub>GS</sub> =V <sub>DS</sub> , I <sub>D</sub> =250uA	0.4	---	1.2	V
I <sub>DSS</sub>	Drain-Source Leakage Current	V <sub>DS</sub> =16V, V <sub>GS</sub> =0V, T <sub>J</sub> =25°C	---	---	1	uA
		V <sub>DS</sub> =16V, V <sub>GS</sub> =0V, T <sub>J</sub> =55°C	---	---	5	
I <sub>GSS</sub>	Gate-Source Leakage Current	V <sub>GS</sub> =±12V, V <sub>DS</sub> =0V	---	---	±100	nA
g <sub>fs</sub>	Forward Transconductance	V <sub>DS</sub> =5V, I <sub>D</sub> =3A	---	10.5	---	S
Q <sub>g</sub>	Total Gate Charge (4.5V)	V <sub>DS</sub> =15V, V <sub>GS</sub> =4.5V, I <sub>D</sub> =3A	---	4.6	---	nC
Q <sub>gs</sub>	Gate-Source Charge		---	0.7	---	
Q <sub>gd</sub>	Gate-Drain Charge		---	1.5	---	
T <sub>d(on)</sub>	Turn-On Delay Time	V <sub>DD</sub> =10V, V <sub>GS</sub> =4.5V, R <sub>G</sub> =3.3Ω I <sub>D</sub> =3A	---	1.6	---	ns
T <sub>r</sub>	Rise Time		---	42	---	
T <sub>d(off)</sub>	Turn-Off Delay Time		---	14	---	
T <sub>f</sub>	Fall Time		---	7	---	
C <sub>iSS</sub>	Input Capacitance	V <sub>DS</sub> =15V, V <sub>GS</sub> =0V, f=1MHz	---	310	---	pF
C <sub>oss</sub>	Output Capacitance		---	49	---	
C <sub>rSS</sub>	Reverse Transfer Capacitance		---	35	---	

**Diode Characteristics**

Symbol	Parameter	Conditions	Min.	Typ.	Max.	Unit
I <sub>S</sub>	Continuous Source Current <sup>1,4</sup>	V <sub>G</sub> =V <sub>D</sub> =0V, Force Current	---	---	6.0	A
V <sub>SD</sub>	Diode Forward Voltage <sup>2</sup>	V <sub>GS</sub> =0V, I <sub>S</sub> =1A, T <sub>J</sub> =25°C	---	---	1.2	V

Note :

- 1.The data tested by surface mounted on a 1 inch<sup>2</sup> FR-4 board with 2OZ copper.
- 2.The data tested by pulsed, pulse width ≤ 300us, duty cycle ≤ 2%
- 3.The power dissipation is limited by 150°C junction temperature
- 4.The data is theoretically the same as I<sub>D</sub> and I<sub>DM</sub>, in real applications, should be limited by total power dissipation.

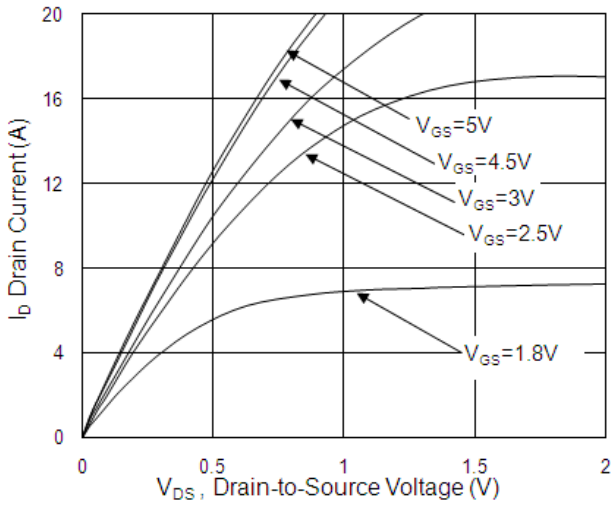
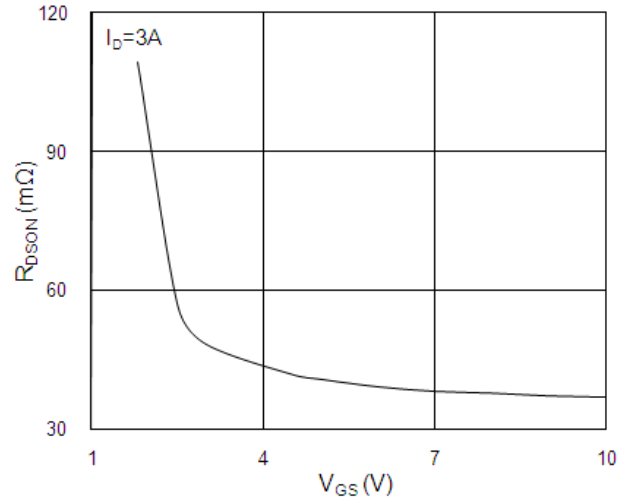
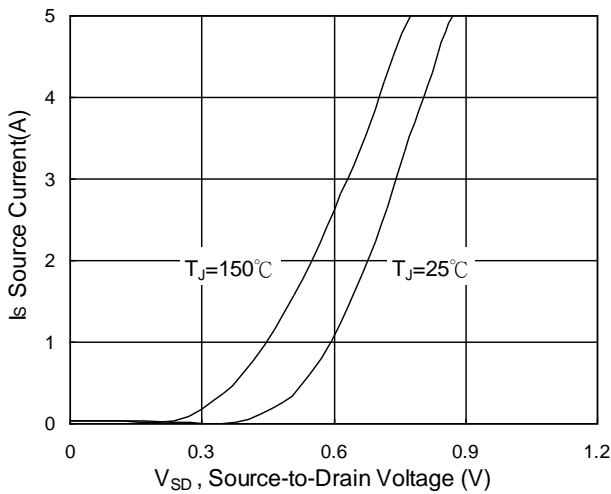
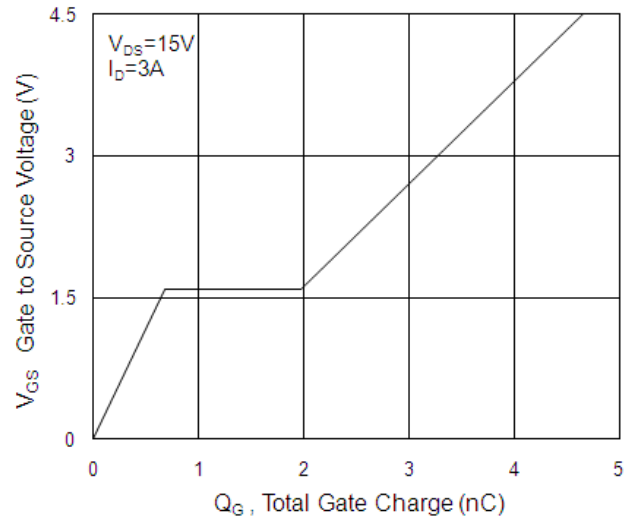
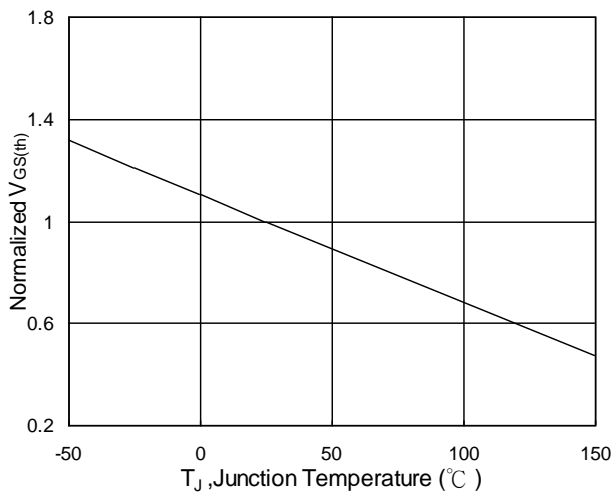
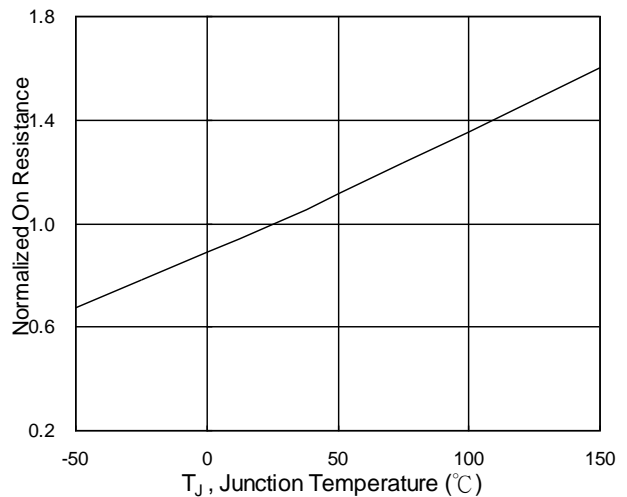
**Typical Characteristics**

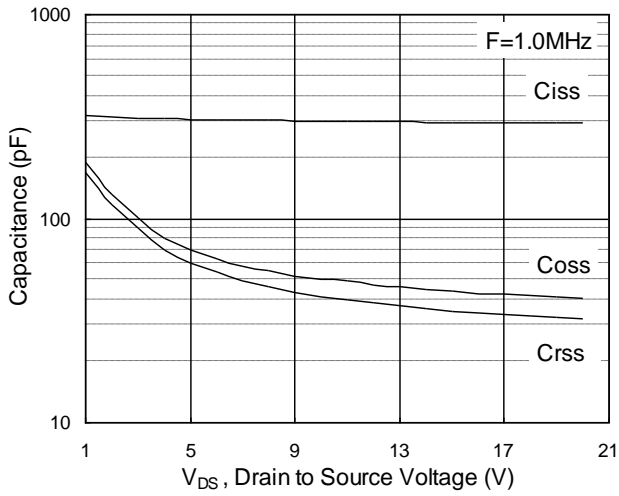
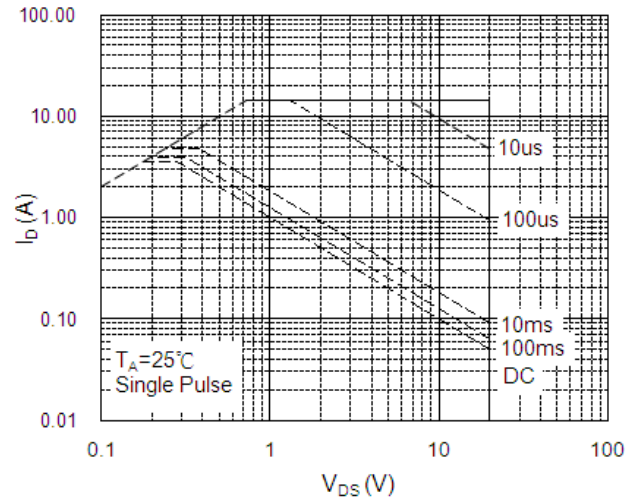
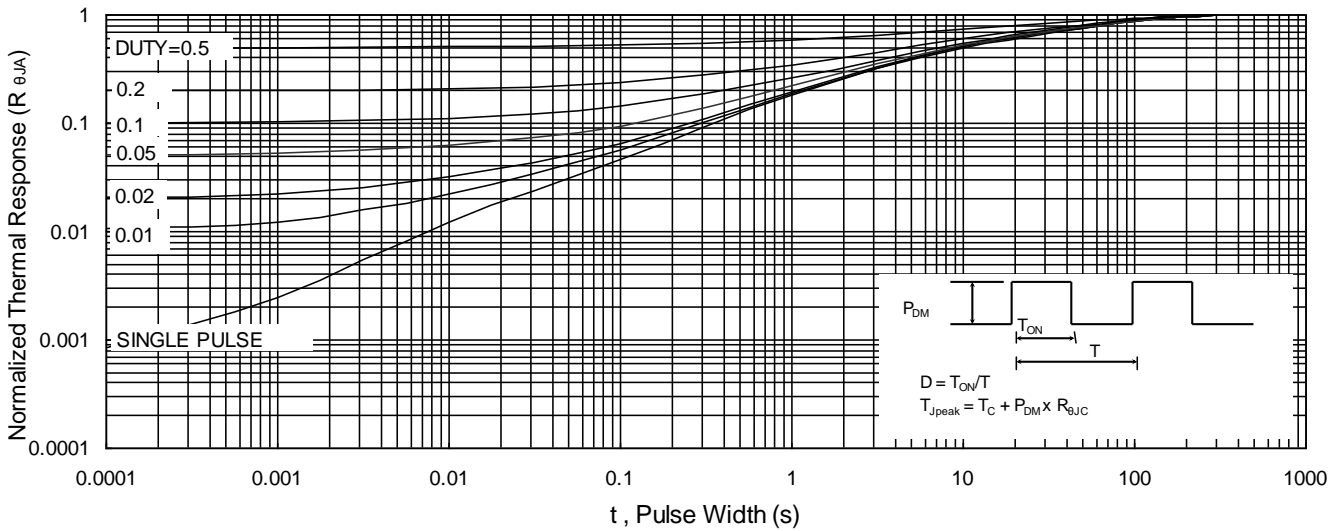
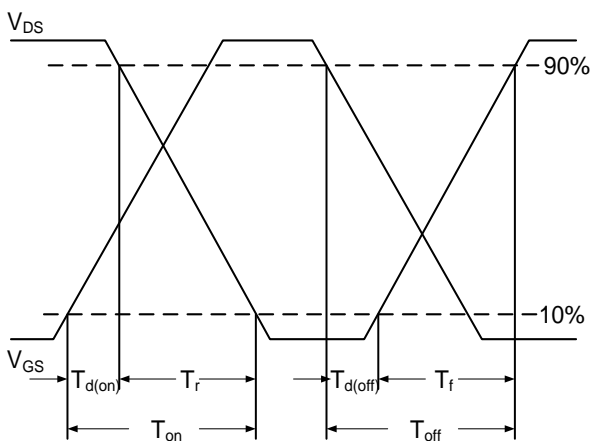
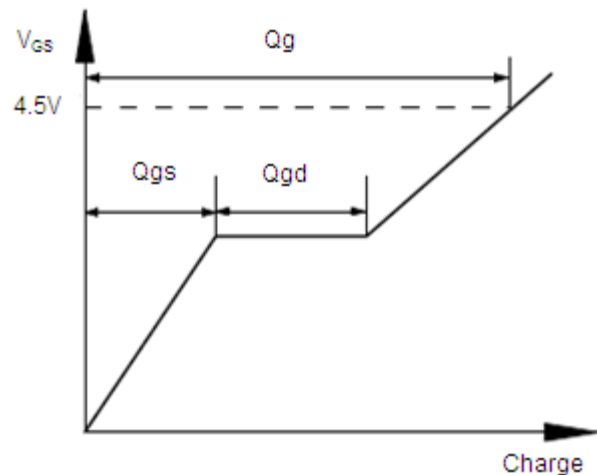
**Fig.1 Typical Output Characteristics**

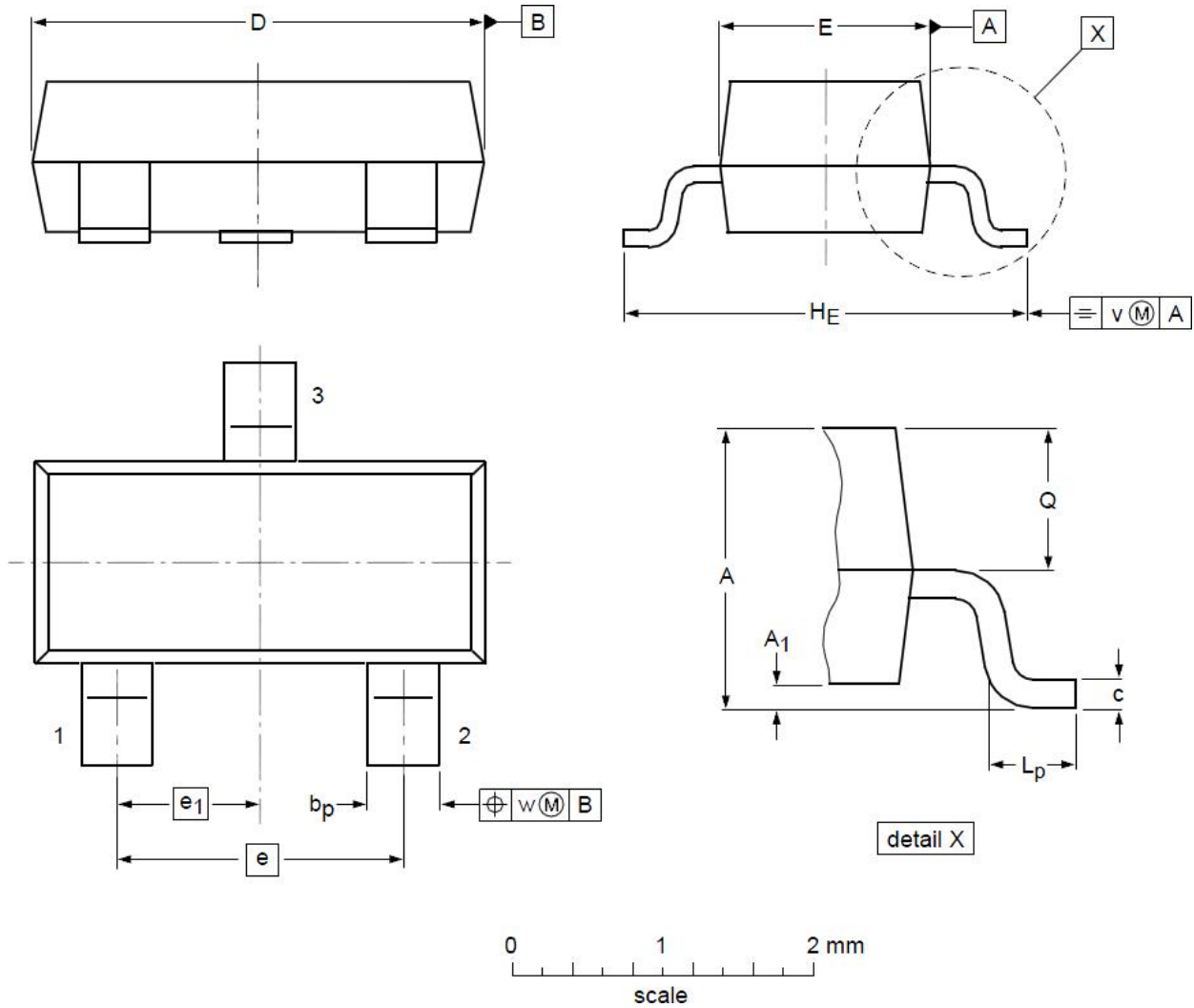
**Fig.2 On-Resistance vs. Gate-Source Voltage**

**Fig.3 Forward Characteristics of Reverse**

**Fig.4 Gate-Charge Characteristics**

**Fig.5 Normalized  $V_{GS(th)}$  vs.  $T_J$** 

**Fig.6 Normalized  $R_{DS(on)}$  vs.  $T_J$**

**Fig.7 Capacitance**

**Fig.8 Safe Operating Area**

**Fig.9 Normalized Maximum Transient Thermal Impedance**

**Fig.10 Switching Time Waveform**

**Fig.11 Gate Charge Waveform**

**Package Mechanical Data-SOT-23**

**DIMENSIONS ( unit : mm )**

Symbol	Min	Typ	Max	Symbol	Min	Typ	Max
A	0.90	1.01	1.15	A <sub>1</sub>	0.01	0.05	0.10
b <sub>p</sub>	0.30	0.42	0.50	c	0.08	0.13	0.15
D	2.80	2.92	3.00	E	1.20	1.33	1.40
e	--	1.90	--	e <sub>1</sub>	--	0.95	--
H <sub>E</sub>	2.25	2.40	2.55	L <sub>p</sub>	0.30	0.42	0.50
Q	0.45	0.49	0.55	v	--	0.20	--
w	--	0.10	--				