

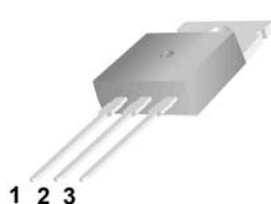
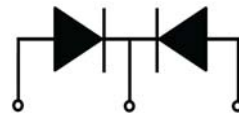

<p>MUR3010CT – MUR3060CT</p> <p>Features:</p> <ul style="list-style-type: none"> <input type="checkbox"/> High surge capacity <input type="checkbox"/> Low Forward Voltage Drop. <input type="checkbox"/> High Current Capability. <input type="checkbox"/> Super Fast Switching Speed For High Efficiency 	<p>TO-220</p>   <p>1. Anode 2. Cathode 3. Anode</p> 
--	--

Absolute Maximum Ratings (Ta=25°C unless otherwise noted)

Parameter	Symbol	MUR 3010 CT	MUR 3015 CT	MUR 3020 CT	MUR 3040 CT	MUR 3060 CT	Unit	
Peak Repetitive Reverse Voltage	V_{RRM}	100	150	200	400	600	V	
Working Peak Reverse Voltage	V_{RWM}	70	105	140	240	420	V	
DC Blocking Voltage	$V_{R(DC)}$	100	150	200	400	600	V	
Average Rectified Forward Current Per Leg Total Device	$I_{F(AV)}$	15 30						A
Peak Rectified Forward Current (Rated V_R , Square Wave, 20 kHz)	I_{FM}	30						A
Nonrepetitive Peak Surge Current(Surge applied at rated load conditions half wave, single phase, 60 Hz)	I_{FSM}	240						A
Operating Junction Temperature and Storage Temperature	TJ, Tstg	-55 to +150						°C
Maximum Thermal Resistance, Junction-to-Case(Per Leg)	$R_{\theta JC}$	3.0			2.0			°C/W

ELECTRICAL CHARACTERISTICS (Per Diode Leg)

Parameter	Symbol	MUR 3010 CT	MUR 3015 CT	MUR 3020 CT	MUR 3040 CT	MUR 3060 CT	Unit
Forward Voltage (Note 1)($I_F = 15\text{ A}$, $T_C = 25^\circ\text{C}$) ($I_F = 15\text{ A}$, $T_C = 125^\circ\text{C}$)	V_F	0.975 0.895			1.35 1.20	1.70 1.50	V
Maximum Instantaneous Reverse Current (Note 1) (Rated DC Voltage, $T_C = 25^\circ\text{C}$) (Rated DC Voltage, $T_C = 125^\circ\text{C}$)	I_R	5 250			10 500		μA
Maximum Reverse Recovery Time ($I_F = 0.5\text{ A}$, $I_R = 1.0\text{ A}$, $I_{REC} = 0.25\text{ A}$)	T_{RR}	35			35		ns

 Note 1.Pulse Test: Pulse Width = 300 μs , Duty Cycle $\leq 2.0\%$

Typical Characteristics

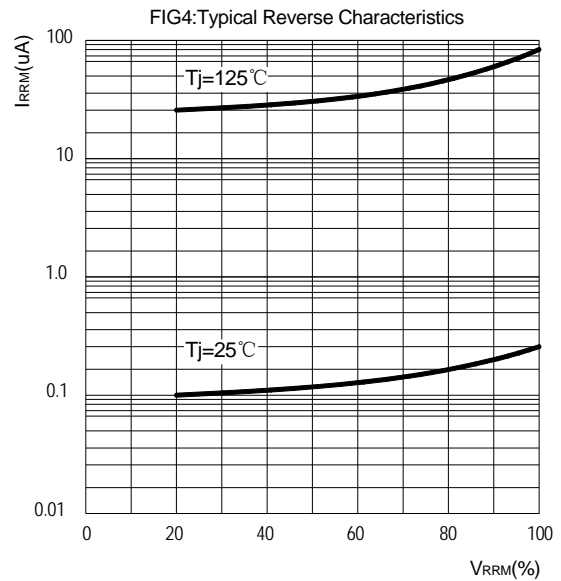
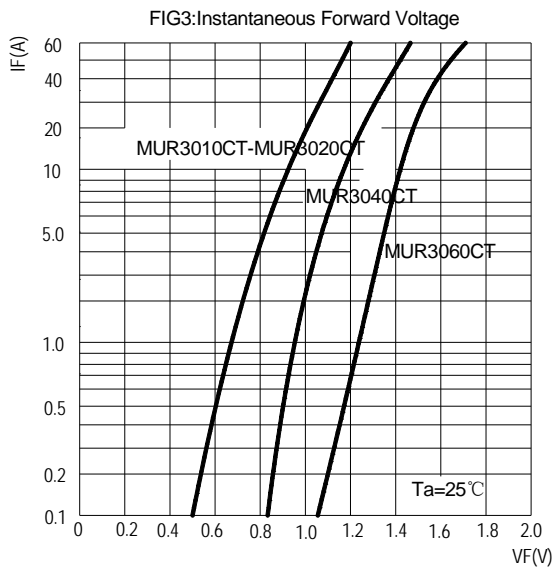
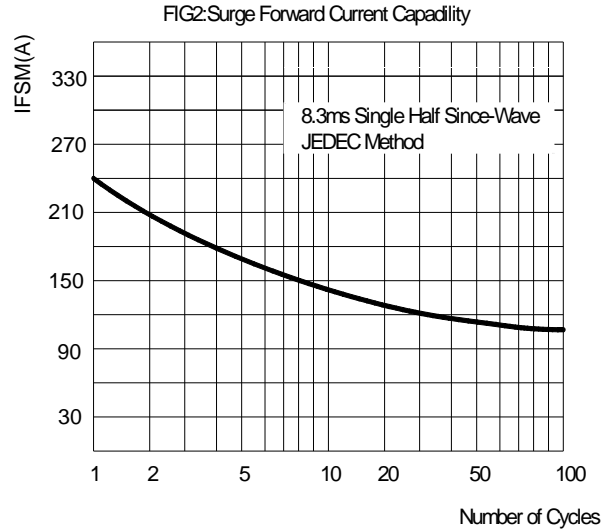
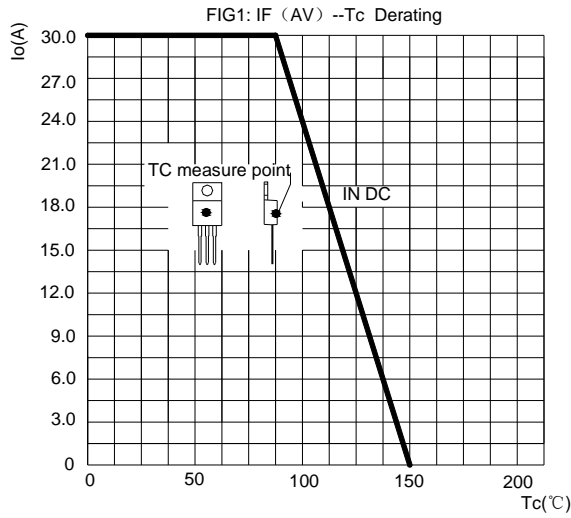
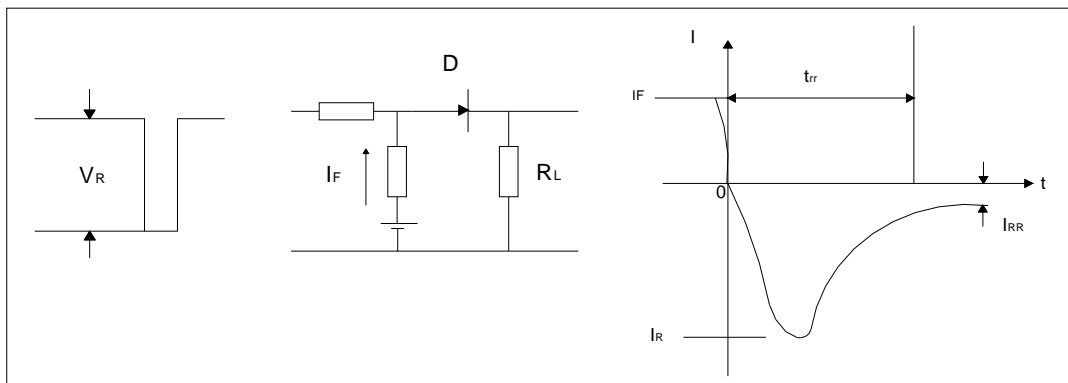

FIG.5: Diagram of circuit and Testing wave form of reverse recovery time



Package Dimension

TO-220

Unit: mm

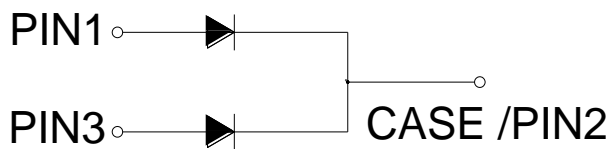
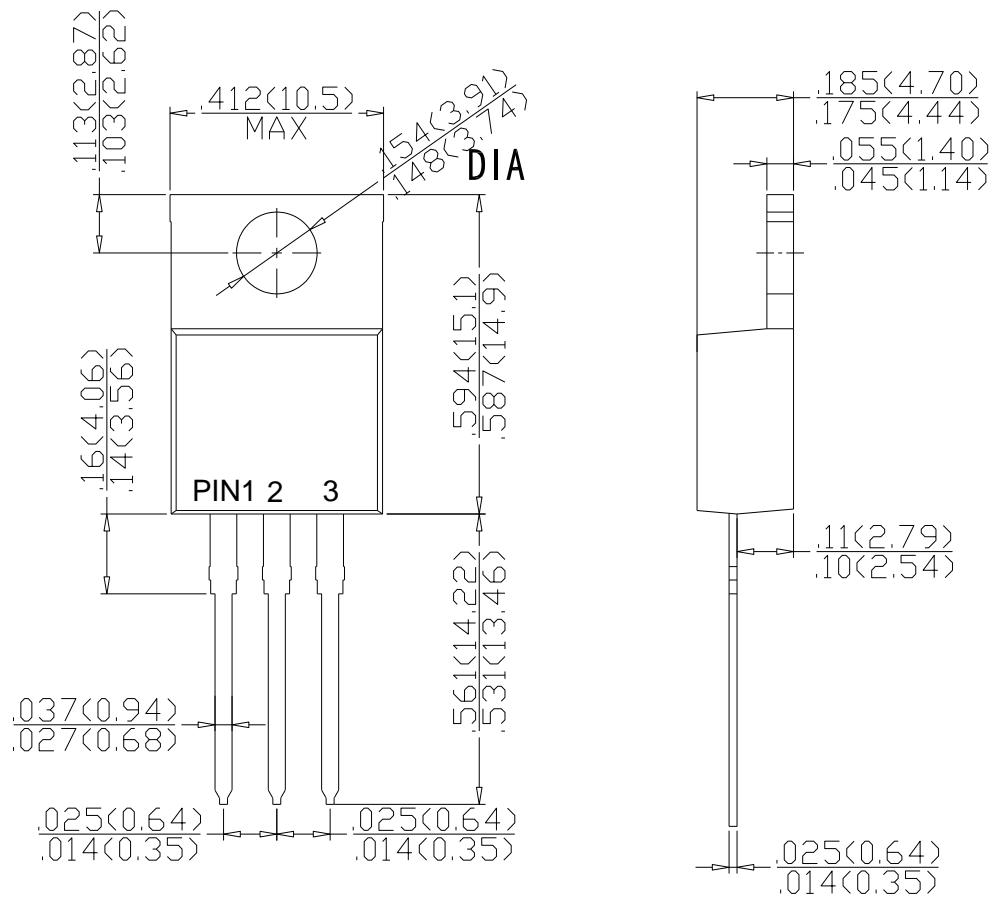

Dimensions in inches and (millimeters)